

Nominal data

Type	4412 M	
Nominal voltage	VDC	12
Nominal voltage range	VDC	7 .. 14
Speed	min ⁻¹	3300
Power input	W	3.8
Min. ambient temperature	°C	-20
Max. ambient temperature	°C	75
Air flow	m ³ /h	184
Sound power level	B	5.3
Sound pressure level	dB(A)	42

ml = Max. load · me = Max. efficiency · fa = Running at free air · cs = Customer specs · cu = Customer unit
Subject to alterations

4412 M

DC axial compact fan

Technical features

Housing material	Fibreglass-reinforced plastic (PBT)
Impeller material	Fibreglass-reinforced plastic (PA)
Mass	0.250 kg
Dimensions	119 x 119 x 38 mm
Direction of air flow	Air exhaust over bars
Direction of rotation	Right, looking at rotor
Bearing	Ball bearings
Lifetime L10 at 40 °C	65000 h
Lifetime L10 at maximum temperature	25000 h
Connection line	Single strands AWG 24, TR 64, bared and tin-plated.
Motor protection	Protected against reverse polarity and locking.
Option	Control inputs such as alarm and speed signals.

4412 M

DC axial compact fan

Product drawing

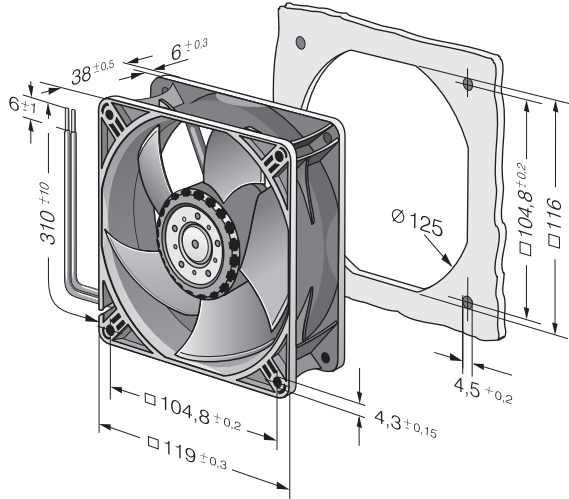

Charts: Air flow

